

24CSJ-S SINGLE CORE STRAIGHT JOINT WITH MECHANICAL CONNECTOR

Up to 24 kV

Application

For jointing copper wire screened polymeric cable to be laid in air or directly buried. The product is fully screened and fully submersible. This product can be installed where installation space is limited (min 1 meter).

Technical characteristics

All joint bodies are tested for AC withstand prior to leaving the factory.

6/10 (12) kV
6.35/11 (12) kV
8.7/15 (17.5) kV
12/20 (24) kV
12.7/22 (24) kV

Design

Cold-shrinkable joint comprising:

1. Extruded triple layer EPDM rubber body.
2. Two layer plate with a semi-conductive and a field control mastic layer.
3. Overall protective EPDM cover.
4. Field control mastic.
5. Water sealing mastic.
6. Copper stocking.
7. Self-adhesive copper tape.
8. Traceability tag.
9. Mechanical conductor connector (included in the standard kit).

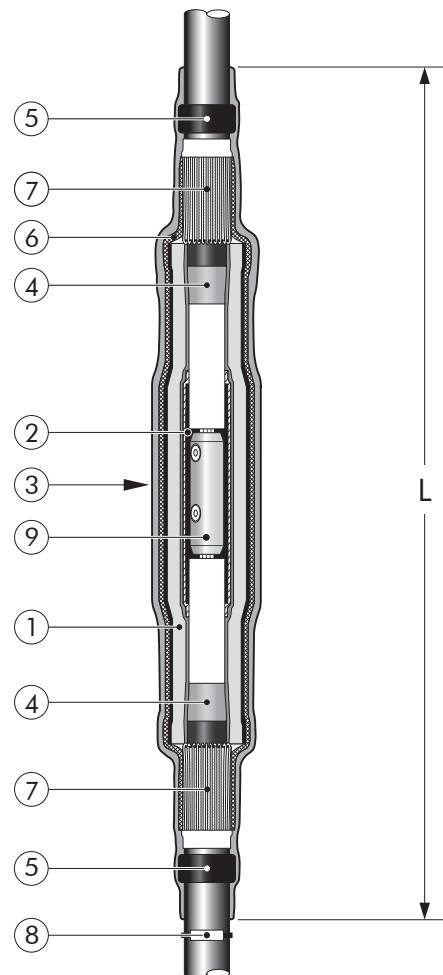

Specifications and standards

The cold-shrinkable 24CSJ-S joint meets the requirements of CENELEC HD 629.1.

Cold-shrinkable straight joint type	L (mm)	Voltage U_m (kV)	Diameter over outer sheath (mm)	Diameter over core insulation (mm)		Conductor sizes for 24 kV (mm ²) (for information only)	
			max	min	max	min	max
24CSJ-S1	650	24	48	18	25	35	95
24CSJ-S2	650	24	48	23	36	95	300

12/2009

Kit contents

The complete cold-shrinkable joint kit comprises the following components:

The kit also comprises a installation hook, adhesive tape, lubricant, wipers, gloves, template, white pencil and installation instructions.

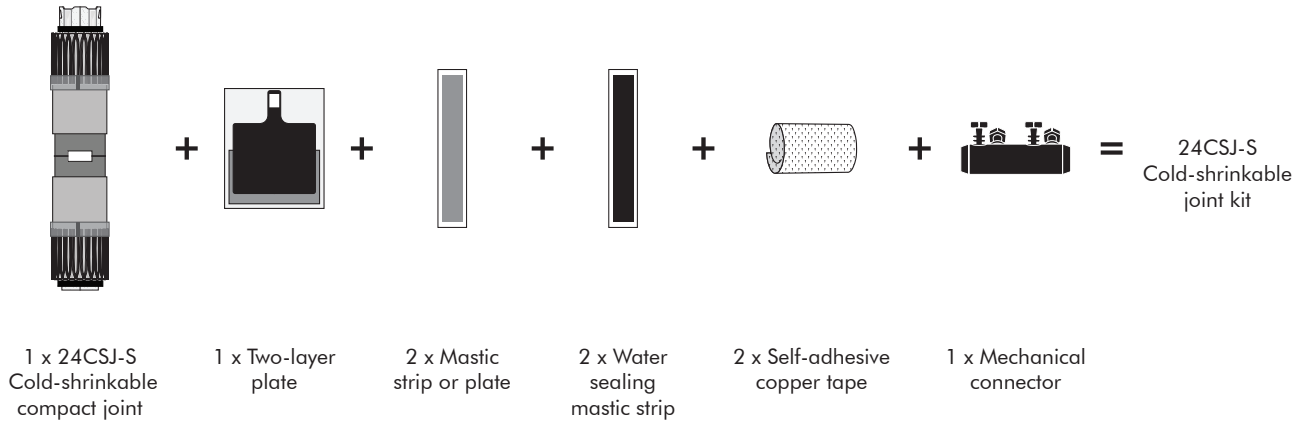



Ordering instructions

Select the part number corresponding to the cable core insulation diameter.

Ordering part number	Conductor sizes (mm ²) (for information only)									Diameter over core insulation (mm)	Diameter over outer sheath (mm)
	35	50	70	95	120	150	185	240	300		
24CSJ-S1	24CSJ-S1									18 - 25	48 max
24CSJ-S2				24CSJ-S2						23 - 33	48 max

Example:

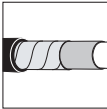
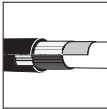
The copper wire screened cable is 24 kV, 120 mm² stranded aluminium with a diameter over core insulation of 25.3 mm. Order a 24CSJ-S2 cold-shrinkable joint kit.

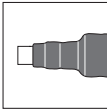
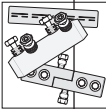
					
For use with copper tape screened cables. Order: -/MT.	For use with Alupec or C 33-226 cables. Please contact our representative.	For use with other cable types. Please contact our representative.	For use with three-core cables. See TT-24CSJ.	Can be supplied as a stop joint. Please contact our representative.	Can be supplied with all common types of conductor connectors.

Euromold
a Nexans company

www.cable-jointing.com
Tel: +44 (0) 1482 37 37 20

info@cable-jointing.com
Fax: +44 (0) 1482 24 20 20

Bonus Power Systems Limited. Head Office and Global Distribution Centre, Connaught Rd, Kingswood Business Park, Hull, E. Yorkshire, UK. HU7 3AP. Specialist Electrical Distribution UK and Worldwide. Low Voltage to Extra High Voltage Cables, Joints, Terminations, Tools, Cable Jointing Accessories.