

24CSJ SINGLE CORE STRAIGHT JOINT

Up to 24 kV

Application

For jointing copper wire screened polymeric cable to be laid in air or directly buried. The product is fully screened and fully submersible.

Technical characteristics

All joint bodies are tested for AC withstand prior to leaving the factory.

6/10 (12) kV
6.35/11 (12) kV
8.7/15 (17.5) kV
12/20 (24) kV
12.7/22 (24) kV

Design

Cold-shrinkable joint comprising:

1. Extruded triple layer EPDM rubber body.
2. Two layer plate with a semi-conductive and a field control mastic layer.
3. Overall protective EPDM cover.
4. Field control mastic.
5. Water sealing mastic.
6. Copper stocking.
7. Self-adhesive copper tape.
8. Traceability tag.
9. Conductor connector (not included in the standard kit).

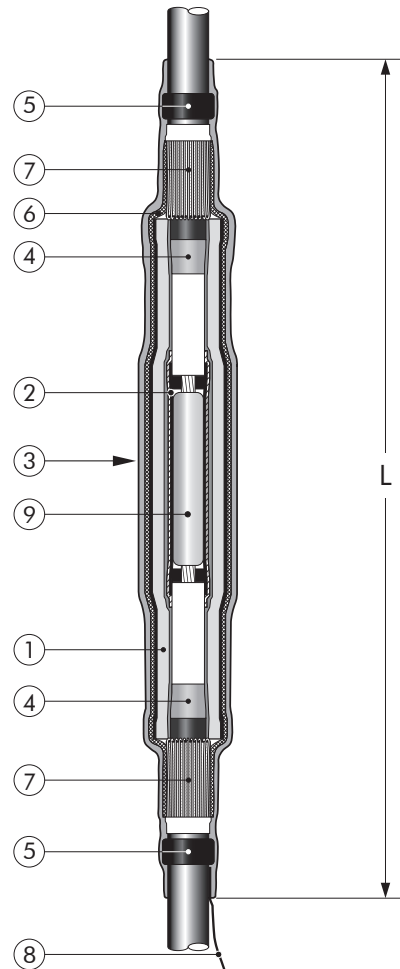

Specifications and standards

The cold-shrinkable 24CSJ joint meets the requirements of CENELEC HD 629.1.

Cold-shrinkable straight joint type	L (mm)	Voltage Um (kV)	Diameter over outer sheath (mm)	Diameter over core insulation (mm)		Conductor sizes for 24 kV (mm ²) (for information only)	
			max	min	max	min	max
24CSJ-1	750	24	46	18	30	35	185
24CSJ-2	750	24	46	23	33	95	300
24CSJ-3	850	24	57	30	54	240	630

12/2009

Kit contents

The complete cold-shrinkable joint kit comprises the following components:

The kit also comprises a pulling hook, adhesive tape, lubricant, wipers, gloves and installation instructions.

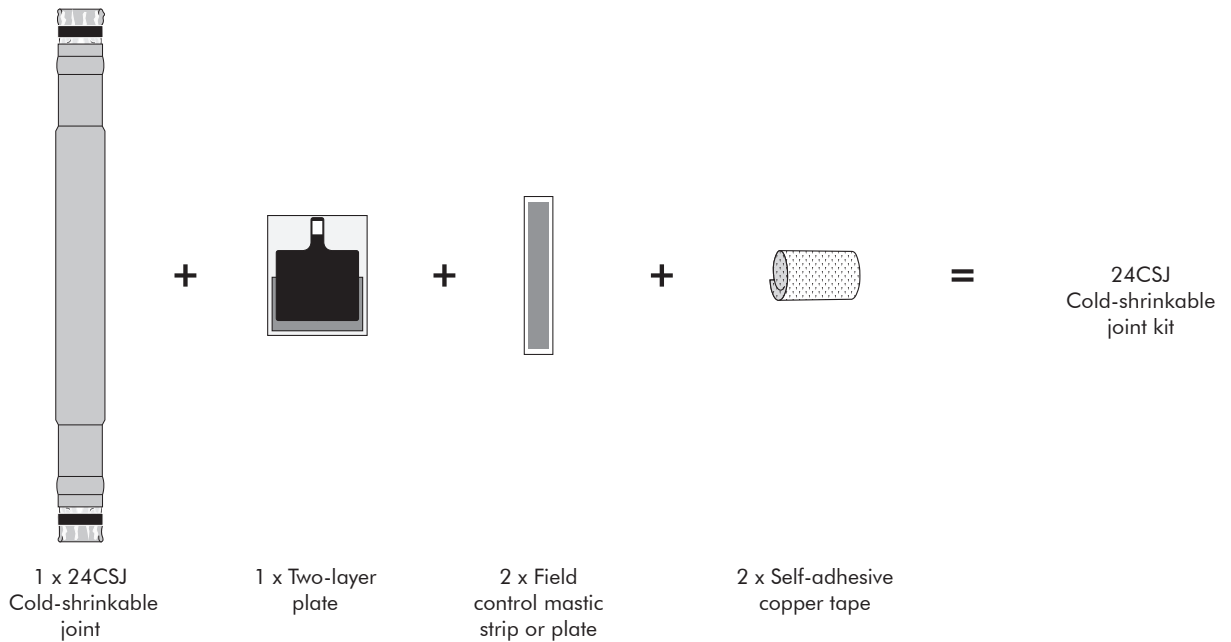

Ordering instructions

Select the part number corresponding to the cable core insulation diameter.

Ordering part number	Conductor sizes (mm ²) (for information only)												Diameter over core insulation (mm)	Diameter over outer sheath (mm)	
	35	50	70	95	120	150	185	240	300	400	500	630			
24CSJ-1	24CSJ-1													18 - 30	46 max
24CSJ-2				24CSJ-2										23 - 33	46 max
24CSJ-3							24CSJ-3							30 - 54	57 max

Example:

The copper wire screened cable is 24 kV, 120 mm² stranded aluminium with a diameter over core insulation of 25.3 mm. Order a 24CSJ-2 cold-shrinkable joint kit.

Joint type	L max (mm)	Dia max (mm)	T max (mm)
24CSJ-1	150	35	8
24CSJ-2	150	35	8
24CSJ-3	280	54	15

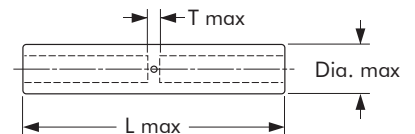

All types of conductor connectors can be used. The conductor connectors must be within the dimensions specified.

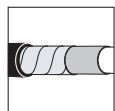

For use with copper tape screened cables.
Order: -/MT.

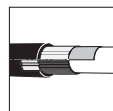

For use with Alupe or C 33-226 cables.
Please contact our representative.



For use with other cable types.
Please contact our representative.



For use with three-core cables.
See TT-24CSJ.

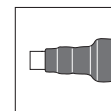

Can be supplied as a stop joint.
Please contact our representative.

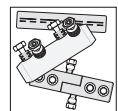

Can be supplied with all common types of conductor connectors.

Euromold
a Nexans company

www.cable-jointing.com
Tel: +44 (0) 1482 37 37 20

info@cable-jointing.com
Fax: +44 (0) 1482 24 20 20

Bonus Power Systems Limited. Head Office and Global Distribution Centre, Connaught Rd, Kingswood Business Park, Hull, E.Yorkshire, UK. HU7 3AP. Specialist Electrical Distribution UK and Worldwide. Low Voltage to Extra High Voltage Cables, Joints, Terminations, Tools, Cable Jointing Accessories.